

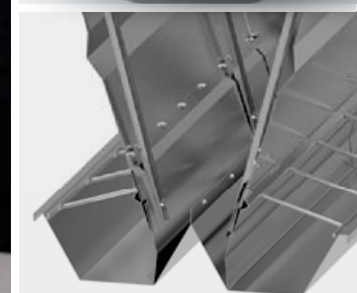

POlnet



Хранилки BOX | Хранилки TUBO | КОРИТА

ХРАНИЛКИ

## ФАКТИ

- ! Полнет е най-големия производител на храники за свинеждството в EU.
- ! Разположен в индустриалния парк на град Татowo Podgorne, на 20 km от град Познан и на 170 km от немската граница.
- ! Модерна производствена база в Zalesie Wielkie, на 90 km от централата.
- ! Проектиране, производство и продажба на висококачествени продукти за селскостопанския сектор.
- ! Клонове в две държави (Австрия, Белгия).
- ! Приходи от износ ~ 60 %.
- ! Износ за всички страни от ЕС, ЮАР, Аржентина, Мексико, Канада, Саудитска Арабия, Китай, Оман, Тайван, Колумбия...
- ! Модерно оборудване.
- ! Използване на най-новите технологии за максимално качество на продукцията.
- ! Персонализирано производство по индивидуалните изисквания на клиентите.
- ! Проекти до ключ.



## НАШАТА СТРУКТУРА

- ! Производствено предприятие около 3 200 м<sup>2</sup>
- ! Отдел за изследователска и развойна дейност
- ! Отдел дизайн
- ! Отдел логистика
- ! Отдел за обслужване на клиенти
- ! Отдел за продажби по целия свят





## СВЕТОВЕН ПРОИЗВОДИТЕЛ НА ХРАНИЛКИ

- | Годишно производство – 25 000 хранилки
- | Разнообразие от хранилки - 150 модела
- | Съотношение на износа ~ 60 % от приходите



## СПЕЦИАЛНО ПРОИЗВОДСТВО

- | Основано на исканията на клиента
- | Проектирано по исканията на клиента
- | Персонализирано производство
- | Индивидуално етикетирание



## ПОДРОБНА ДОКУМЕНТАЦИЯ

- | Наръчници
- | Инструкции за монтаж
- | Техническа документация
- | Учебни филми



## ТРАНСПОРТ

- | Камioni
- | Кораби/контейнери
- | Разглобени
- | Сглобени



## ЕВРОПЕЙСКИ ПРОИЗВОДИТЕЛ

- | Кратко време за изпълнение
- | Международно покритие



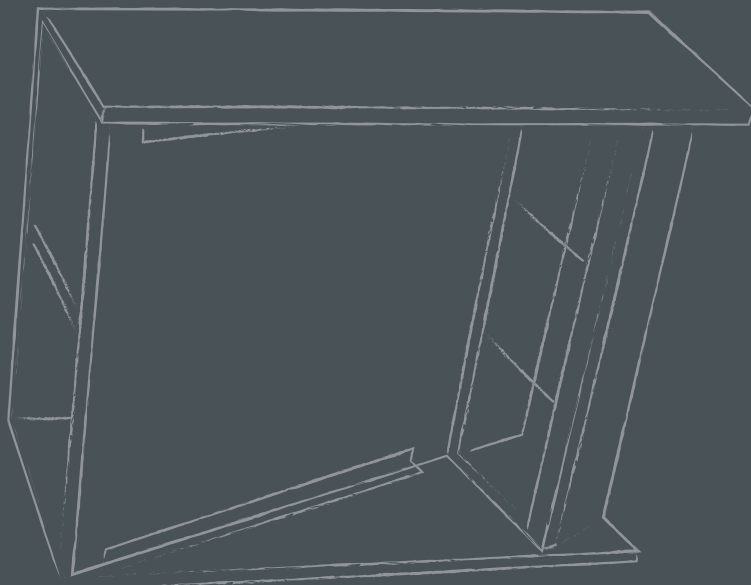
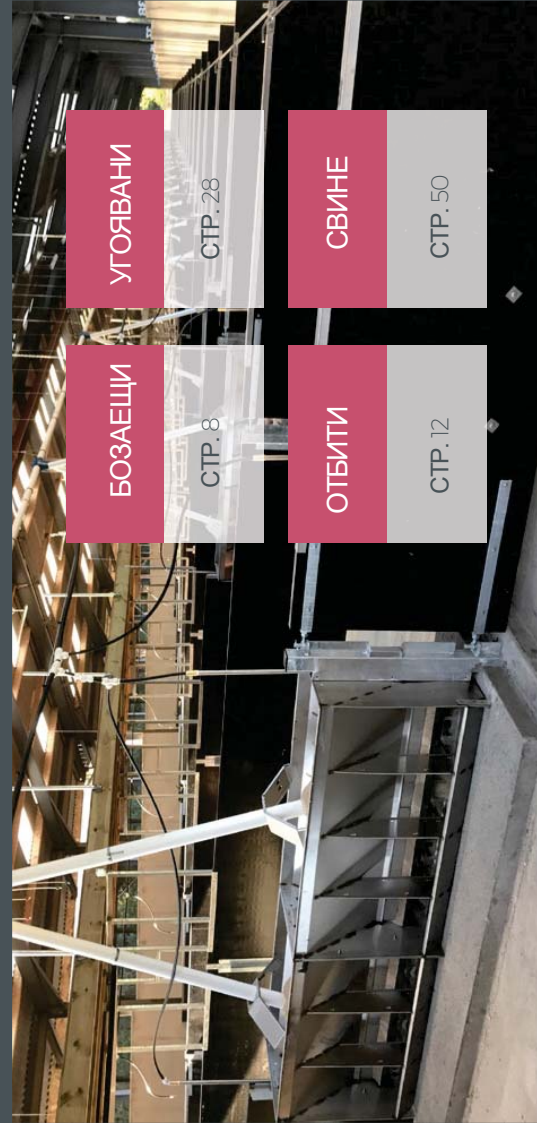

В

О

Х



## FOR PIGLETS ЗА БОЗАЕЦИ ПРАСЕНЦА

EN

Box feeders for dry feed, pellet or meal. Aimed for piglets up to 7kg. Assure easy, quick and efficient access to feed for all animals in a group. Animal friendly form, no sharp edges, minimum feed waste, easy to clean.

BG

Хранилки тип Бокс за сух фураж, гранулиран или брашенест. За прасенца до 7 kg. Осигурете лесен, бърз и ефективен достъп до храна за всички животни в групата. Удобен за животните дизайн, без остри ръбове, минимално разпиляване, лесно почистване.

## STANDARD

EN

- Made of strong material PE.
- Metal elements made of stainless steel (AISI 430).
- Amount of feed is adjustable by screw on front plate

BG

- Изработени от здрав материал PE.
- Метални елементи от неръждаема стомана (AISI 430).
- Количеството фураж в коритото се регулира чрез винт на предната плоскост.

AP2P Standard



Following options available / Предлагат се следните модели

	A	B	C	D	Kg/l	Бр. животни	Тегло на животните/kg
1   AP2P Стандарт	450	302	205	95	9/15	Прасило	До 7kg
2   AP3P Стандарт	450	447	205	95	13/19	Прасило	До 7kg



AGRAR

EN

- | Made of strong material PE.
- | Tough and metal elements made of stainless steel (AISI 430)
- | Amount of feed is adjustable by screw on front plate.

BG

- | Изработени от здрав материал PE.
- | Метални елементи от неръждаема стомана (AISI 430).
- | Количеството фураж в коритото се регулира чрез винт на предната плоскост.

AP3P AGRAR

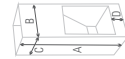
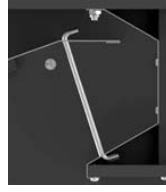

Following options available / Предлагат се следните модели

A	B	C	D	Kg/l	бр. животни	Тегло на животните/kg
430	310	2.05	95	9/13	Прасило	До 7kg
430	455	2.05	95	13/19	Прасило	До 7kg



INOX

EN

- | Made entirely of stainless steel (AISI 430).
- | Precise dosing system.

BG

- | Изработени изцяло от неръждаема стомана (AISI 430).
- | Прецизна дозираща система.

AP3P INOX

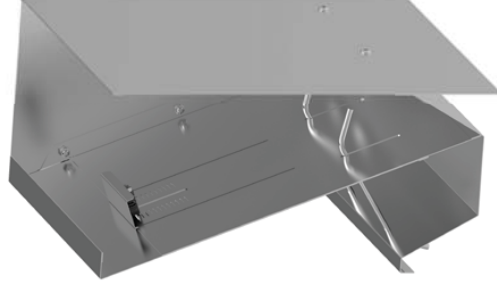

Following options available / Предлагат се следните модели

A	B	C	D	Kg/l	бр. животни	Тегло на животните/kg
420	300	200	96	9/13	Прасило	До 7kg
420	450	200	96	13/19	Прасило	До 7kg



EN

Box feeders for dry feed, pellet or meal. Aimed for weaners from 7 to 45 kg. Assure easy, quick and efficient access to feed for all animals in a group. One feeding place is enough for 8 to max 10 animals. Animal friendly form, no sharp edges, minimum feed waste, easy to clean. All feeders available in assembled or unassembled option, depending on request.

BG

Хранилки тип Бокс за комбиниран фураж, гранулиран или брашнест. Предназначен за отбити прасета от 7 до 45 kg. Осигурете лесен, бърз и ефективен достъп до храна за всички животни в група. Едно място за хранене е достатъчно за 8 до максимум 10 животни. Подходящ за животните дизайн, без остри ръбове, минимално разпиляване на фураж, лесно почистване. Всички хранилки се предлагат в сглобен или разглобен вариант, в зависимост от заявката.

## ЗА ОТБИТИ ПРАСЕТА

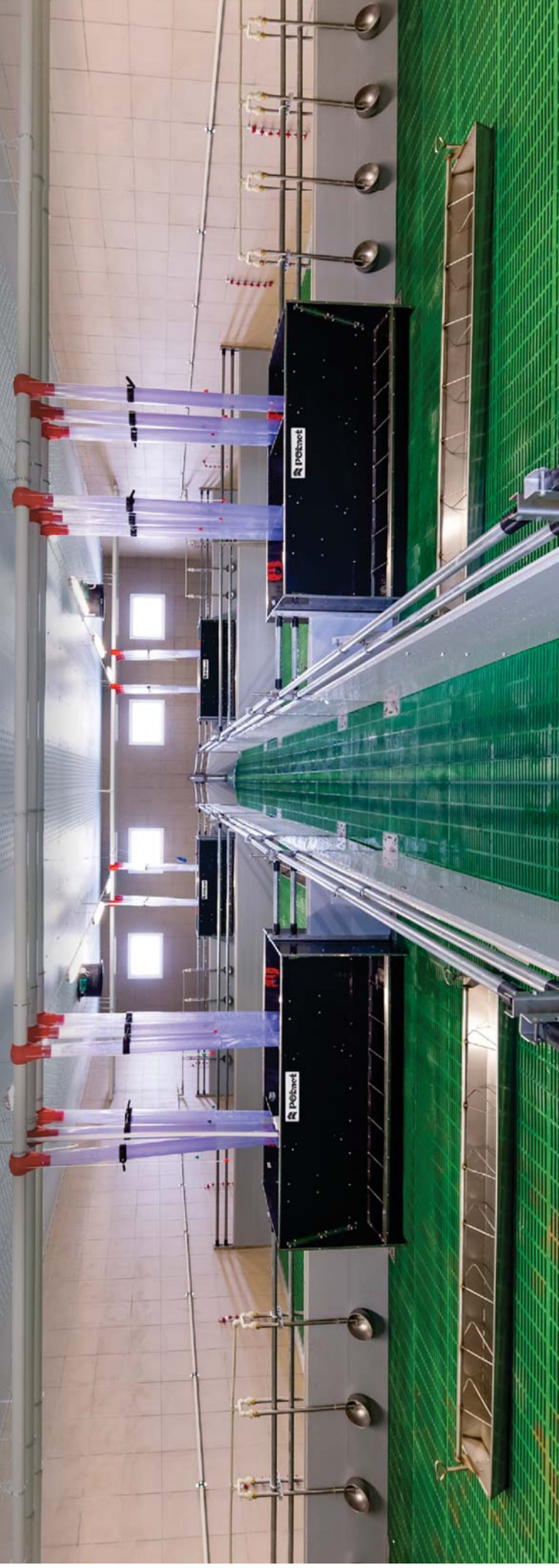



## STANDARD

## EN

- Made of strong material PE.
- Metal elements made of stainless steel (AISI 430).
- Trough edge preventing feed waste.
- Precise and durable feed flow adjustment.

## BG

- Произведени от здрав материал PE.
- Метални детайли от неръждаема стомана (AISI 430).
- Формата на коритото предотвратява разлипяване на фураж.
- Прецизно и надеждно устройство за дозиране на фуража.

## AP6W/2 STANDARD

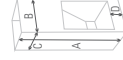

Following options available / Предлага се следните модели

	A	B	C	D	kg/l	бр. животни	Тегло на животните/kg
1   AP 2W Standard	740	410	310	125	43	16-20	7-45kg
2   AP 2W/2 Standard	740	410	620	125	87	32-40	7-45kg
3   AP 3W Standard	740	610	310	125	66	24-30	7-45kg
4   AP 3W/2 Standard	740	610	620	125	131	48-60	7-45kg
5   AP 4W Standard	740	810	310	125	88	32-40	7-45kg
6   AP 4W/2 Standard	740	810	620	125	175	64-80	7-45kg
7   AP 5W Standard	740	1010	310	125	110	40-50	7-45kg
8   AP 5W/2 Standard	740	1010	620	125	220	80-100	7-45kg
9   AP 6W Standard	740	1210	310	125	132	48-60	7-45kg
10   AP 6W/2 Standard	740	1210	620	125	264	96-120	7-45kg
11   AP 7W Standard	740	1400	310	125	153	56-70	7-45kg
12   AP 7W/2 Standard	740	1400	620	125	307	112-140	7-45kg

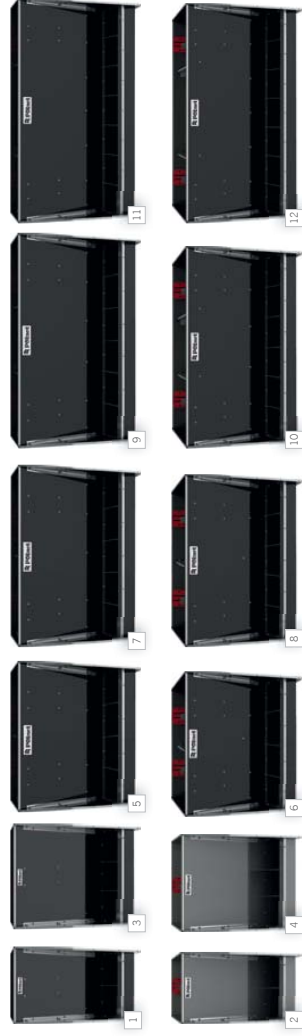



## MF

## EN

- Side walls made of strong material PE.
- Front wall made of stainless steel (AISI 430).
- Special cross bending on a front wall – stronger construction.
- Trough made of stainless steel (AISI 304).
- Precise and durable feed flow adjustment.
- Trough edge preventing feed waste.
- OPTIONAL - additional down separation between feed places.
- OPTIONAL - feed pipe support.

## BG

- Странични стени от здрав материал PE.
- Предна стена от неръждаема стомана (AISI 430).
- Специално напречно огъване на предната стена – по-здрава конструкция.
- Корито от неръждаема стомана (AISI 304).
- Прецизен и здрав регулатор на хранявания поток.
- Ръбът на корито предотвратява разгилването на фураж.
- ОПЦИЯ - допълнително разделяне надолу между местата за хранене.
- ОПЦИЯ – опора за храняваща тръба.

## AP7W/2 MF



ОПОРА ЗА ЗАРЖДАЩАТА ТРЪБА



Following options available / Предлагат се следните модели

	Height [mm]	Width total included the sides walls [mm]	Width inside the trough [mm]	Дълбочина [mm]	Тегло на животните/kg
1   AP2W MF	740	408	310	310	134
2   AP2W/2 MF	740	408	390	620	134
3   AP3W MF	740	608	590	310	134
4   AP3W/2 MF	740	608	590	620	134
5   AP4W MF	740	808	790	310	134
6   AP4W/2 MF	740	808	790	620	134
7   AP5W MF	740	977	959	310	134
8   AP5W/2 MF	740	977	959	620	134
9   AP6W MF	740	1208	1190	310	134
10   AP6W/2 MF	740	1208	1190	620	134
11   AP7W MF	740	1398	1380	310	134
12   AP7W/2 MF	740	1398	1380	620	134



1



3



5



7



9



11



2



4



6



8



10



12

## AGRAR

EN

- ▮ Made of strong material PE
- ▮ Tough and metal elements made of stainless steel ( AISI 430).
- ▮ Precise and durable feed flow adjustment .

## AP3W/2 AGRAR

BG

- ▮ Произведени от здрав материал PE
- ▮ Коритото и металните детайли са от нерждаема стомана (AISI 430).
- ▮ Прецизна и здрава система за регулиране на притока на фураж

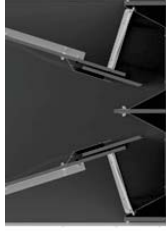
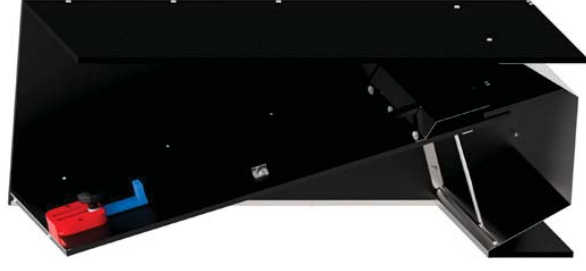

## Following options available / Предлагани модели

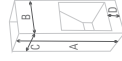

	A	B	C	D	D	Кг/л	Брой животни	Тегло на животини/кг
1   AP 2W Agrar	740	410	310	120	43		16-20	7-45kg
2   AP 2W/2 Agrar	740	410	620	120	87		32-40	7-45kg
3   AP 3W Agrar	740	610	310	120	66		24-30	7-45kg
4   AP 3W/2 Agrar	740	610	620	120	131		48-60	7-45kg
5   AP 4W Agrar	740	810	310	120	88		32-40	7-45kg
6   AP 4W/2 Agrar	740	810	620	120	175		64-80	7-45kg
7   AP 5W Agrar	740	1010	310	120	110		40-50	7-45kg
8   AP 5W/2 Agrar	740	1010	620	120	220		80-100	7-45kg
9   AP 6W Agrar	740	1210	310	120	132		48-60	7-45kg
10   AP 6W/2 Agrar	740	1210	620	120	264		96-120	7-45kg
11   AP 7W Agrar	740	1400	310	120	153		56-70	7-45kg
12   AP 7W/2 Agrar	740	1400	620	120	307		112-140	7-45kg





## SEP

EN

- ▮ Made of strong material PE.
- ▮ Metal elements made of stainless steel (AISI 430).
- ▮ Precise and durable feed flow adjustment.
- ▮ Additional divider on trough, enabling individual access to trough, less stress for animals.

BG

- ▮ Произведени от здрав материал PE.
- ▮ Металните детайли са от неръждаема стомана (AISI 430).
- ▮ Прецизен и здрав регулиращ механизъм за притока на фураж на всяко животно (по-малко стрес).
- ▮ Допълнителни делители в коритото, за индивидуален достъп до коритото и по-малко стрес.

## AP5W/2 SEP

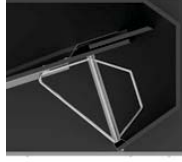

## Following options available / Предлагани модели

	A	B	C	D	Kg/l	Брой животни	Тегло на животното /kg
1   AP 2W SEP	740	410	310	125	43	16-20	7-4,5kg
2   AP 2W/2 SEP	740	410	620	125	87	32-40	7-4,5kg
3   AP 3W SEP	740	610	310	125	66	24-30	7-4,5kg
4   AP 3W/2 SEP	740	610	620	125	131	48-60	7-4,5kg
5   AP 4W SEP	740	810	310	125	88	32-40	7-4,5kg
6   AP 4W/2 SEP	740	810	620	125	175	64-80	7-4,5kg
7   AP 5W SEP	740	1010	310	125	110	40-50	7-4,5kg
8   AP 5W/2 SEP	740	1010	620	125	220	80-100	7-4,5kg
9   AP 6W SEP	740	1210	310	125	132	48-60	7-4,5kg
10   AP 6W/2 SEP	740	1210	620	125	264	96-120	7-4,5kg
11   AP 7W SEP	740	1400	310	125	153	56-70	7-4,5kg
12   AP 7W/2 SEP	740	1400	620	125	307	112-140	7-4,5kg



## LUX

EN

- || Made of strong material PE.
- || Tough and metal elements made of stainless steel (AISI 430).
- || Precise and durable stainless steel feed flow adjustment.
- || Stainless steel inside bolt.
- || Reinforced front wall.
- || Longer durability.

BG

- || Изработени от здрав материал PE.
- || Корито и метални детайли от неръждаема стомана (AISI 430).
- || Прецизен и здрав дозирач механизъм за притока на фураж.
- || Неръждаем вътрешен болт.
- || Усилена предна поклок.
- || Високи здравина и издръжливост.



AP7W/2 LUX



## Following options available / Предлагани модели

	A	B	C	D	Kg/l	Брой жилисти	Тегло на жилище/kg
1   AP 2W LUX	740	410	310	125	43	16-20	7-45kg
2   AP 2W/2 LUX	740	410	620	125	87	32-40	7-45kg
3   AP 3W LUX	740	610	310	125	66	24-30	7-45kg
4   AP 3W/2 LUX	740	610	620	125	131	48-60	7-45kg
5   AP 4W LUX	740	810	310	125	88	32-40	7-45kg
6   AP 4W/2 LUX	740	810	620	125	175	64-80	7-45kg
7   AP 5W LUX	740	1010	310	125	110	40-50	7-45kg
8   AP 5W/2 LUX	740	1010	620	125	220	80-100	7-45kg
9   AP 6W LUX	740	1210	310	125	132	48-60	7-45kg
10   AP 6W/2 LUX	740	1210	620	125	264	96-120	7-45kg
11   AP 7W LUX	740	1400	310	125	153	56-70	7-45kg
12   AP 7W/2 LUX	740	1400	620	125	307	112-140	7-45kg





## WITH DRINKER

## С ПОИЛКА

## EN

- Made of strong material PE.
- Trough and drinkers made of stainless steel (AISI 304).
- Other metal elements made of stainless steel (AISI 430).
- Precise and durable feed flow adjustment.
- With integrated drinking bowl separated from feeding area, fitted with stainless steel drinking nipple.

## BG

- Изработени от здрав материал PE.
- Корито и метални детайли от неръждаема стомана (AISI 304).
- Другите метални детайли са от неръждаема стомана (AISI 430)
- Прецизен и здрав дозираещ механизъм за прилога на фураж
- Неръждаем вътрешен болт.
- Усилена предна лоскост.
- Високи здравина и издръжливост.

## AP3+2W2

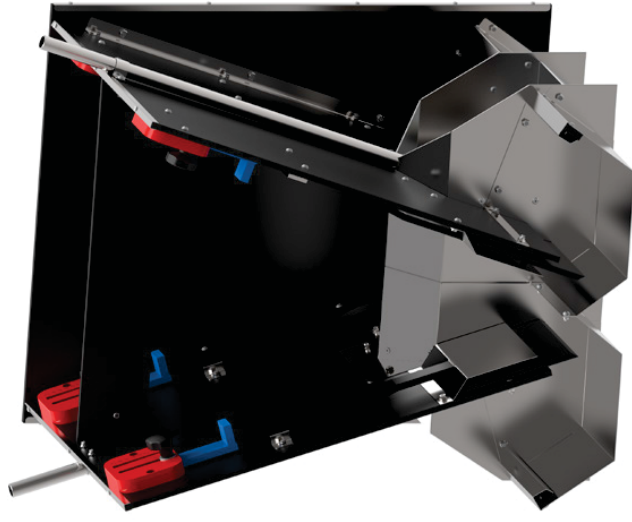

## Following options available / Предлагани модели

	A	B	C	D	Кг/л	Брой животни	Темпо на животиците/кг
1   AP1+W	740	400	310	140	38	8-10	7-45kg
2   AP1+W/2	740	400	620	140	76	16-20	7-45kg
3   AP2+W	740	600	310	140	59	16-20	7-45kg
4   AP2+W/2	740	600	620	140	118	32-40	7-45kg
5   AP2+2W	740	780	310	140	76	16-20	7-45kg
6   AP2+2W/2	740	780	620	140	152	32-40	7-45kg
7   AP3+2W	740	980	310	140	97	24-30	7-45kg
8   AP3+2W/2	740	980	620	140	194	48-60	7-45kg

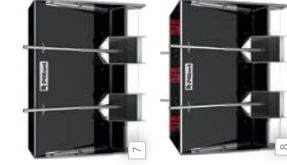

## INOX

EN

- ▮ Made entirely of stainless steel AISI 430 (AISI 304 on request).
- ▮ Precise and durable feed flow adjustment.
- ▮ Foot plate enabling anchoring to floor.
- ▮ Trough edge with additional metal bar preventing feed waste.

AP5W/2 INOX

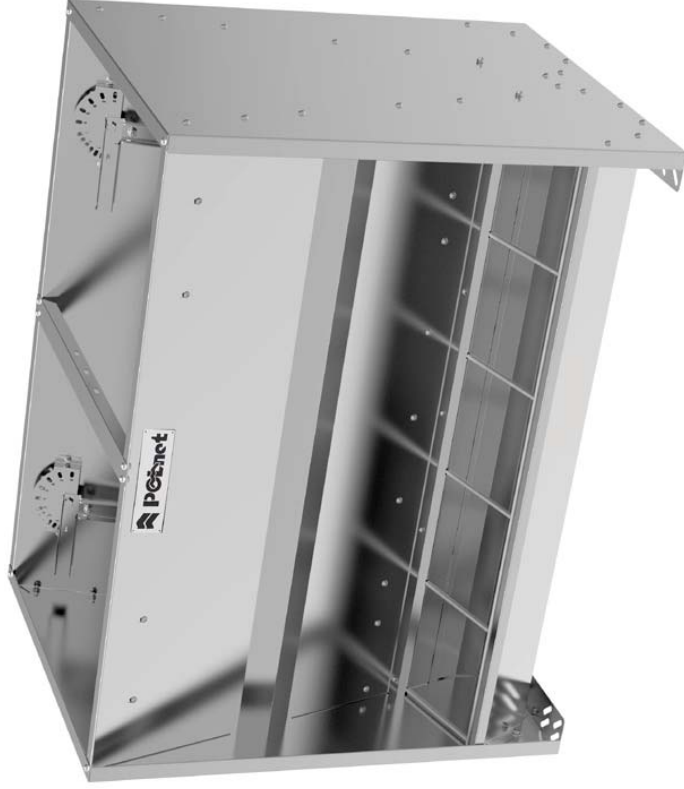

## НЕРЪЖДАЕМИ

BG

- ▮ Изработени изцяло от неръждаема стомана AISI 430 (AISI 304 по заявка).
- ▮ Прецизни и издръжлив регулиращ механизъм за фуража.
- ▮ Фиксирани плънки за закрепване към пода.
- ▮ Ръбът на коритото с допълнителна метална шина, предотвратяваща разпиляването на фураж.

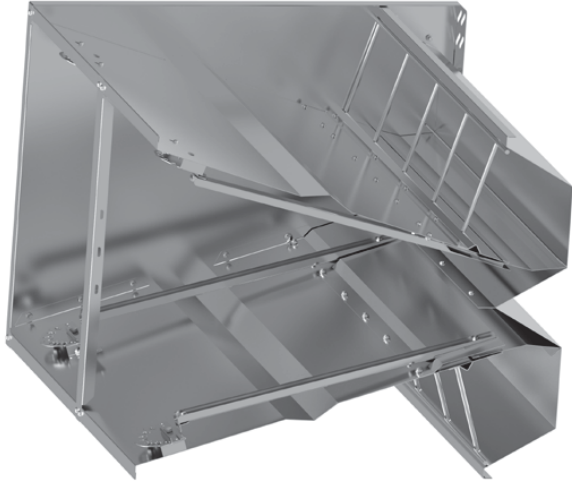

## Following options available / Предлагани модели

	A	B	C	D	Kg/l	Брой животни	Тегло на животно/kg
1   AP2W INOX	750	392	300	145	42	16-20	7-45kg
2   AP2W/2 INOX	750	392	600	145	84	32-40	7-45kg
3   AP3W INOX	750	592	300	145	64	24-30	7-45kg
4   AP3W/2 INOX	750	592	600	145	128	48-60	7-45kg
5   AP4W INOX	750	792	300	145	86	32-40	7-45kg
6   AP4W/2 INOX	750	792	600	145	172	64-80	7-45kg
7   AP5W INOX	750	992	300	145	107	40-50	7-45kg
8   AP5W/2 INOX	750	992	600	145	214	80-100	7-45kg
9   AP6W INOX	750	1192	300	145	129	48-60	7-45kg
10   AP6W/2 INOX	750	1192	600	145	258	96-120	7-45kg
11   AP7W INOX	750	1392	300	145	151	56-70	7-45kg
12   AP7W/2 INOX	750	1392	600	145	302	112-140	7-45kg





## FOR FATTENERS | ЗА УГОЯВАНИ ПРАСЕТА

EN

Box feeders for dry feed, pellet or meal. Aimed for fatteners from 30 to 125 Kg. Assure easy, quick and efficient access to feed for all animals in a group. One feeding place is enough for 8 to max. 10 animals. Animal friendly form, no sharp edges, minimum feed waste, easy to clean. All feeders available in assembled or unassembled option, depending on request.

BG

Хранилки тип бокс за сух фураж, гранулиран или брашноест. Предназначени за угоявани прасета от 30 до 125 Kg. Осигуряват лесен, бърз и ефективен достъп до храна за всички животни в групата. Едно място за хранене е достатъчно за 8 до 10 животни. Подходящ за животните дизайн, без остри ръбове, с минимално разпилване на фураж, лесни за почистване. Всички хранилки се предлагат в сглобен или разглобен вариант, в зависимост от заявката.



## STANDARD

EN

- ▮ Made of strong material PE.
- ▮ Metal elements made of stainless steel (AISI 430).
- ▮ Tough edge preventing feed waste.
- ▮ Precise and durable feed flow adjustment.

BG

- ▮ Изработени от здрав материал PE.
- ▮ Металните детайли от нерждаема стомана AISI 430.
- ▮ Прецизен и издръжлив регулиращ механизъм за фуража.
- ▮ Ръбът на коритото предотвратява разливането на фураж.

## AP4T/2 STANDARD

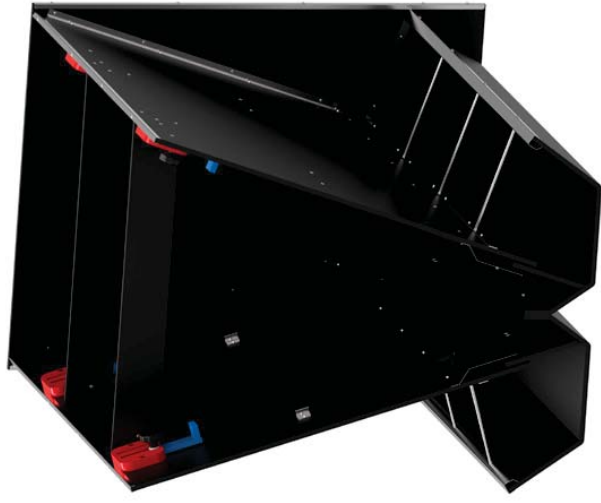

## Following options available / Предлагани модели

	A	B	C	D	Kg/l	Брой животни	Тегло на животите/Kg
1   AP 1T Standard	990	319	400	180	57	8-10	30-125kg
2   AP 1T/2 Standard	990	319	800	180	114	16-20	30-125kg
3   AP 2T Standard	990	614	400	180	114	16-20	30-125kg
4   AP 2T/2 Standard	990	614	800	180	228	32-40	30-125kg
5   AP 3T Standard	990	914	400	180	172	24-30	30-125kg
6   AP 3T/2 Standard	990	914	800	180	344	48-60	30-125kg
7   AP 4T Standard	990	1214	400	180	230	32-40	30-125kg
8   AP 4T/2 Standard	990	1214	800	180	460	64-80	30-125kg
9   AP 5T Standard	990	1514	400	180	288	40-50	30-125kg
10   AP 5T/2 Standard	990	1514	800	180	576	80-100	30-125kg





## MF

## EN

- Side walls made of strong material PE.
- Front wall made of stainless steel (AISI 430).
- Special cross bending on a front wall - stronger construction.
- Trough made of stainless steel (AISI 304).
- Precise and durable feed flow adjustment.
- Trough edge preventing feed waste.
- OPTIONAL - feed pipe support.

## BG

- Страничните стени са от здрав материал PE.
- Предна стена от неръждаема стомана (AISI 430).
- Специално напречно огъване на предна стена – по-здрава конструкция.
- Корито от неръждаема стомана (AISI 304).
- Прецизен и издръжлив регулиращ механизъм на притока на фураж.
- Ръбът на коритото предотвратява разпиляването на фураж.
- ОПЦИЯ – опора за захранващата тръба.

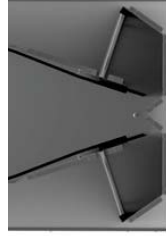

FEED PIPE SUPPORT

ОПОРА ЗА ЗАРНЕЖДАЩАТА ТРЪБА



## AP5T/2 MF



## Following options available / Предлагани модели

	Height [mm] Височина [mm]	External trough width [mm] Външна ширина корито [mm]	Internal trough width [mm] Вътрешна ширина корито [mm]	Depth [mm] Дълбочина [mm]	Height on trough [mm] Височина на коритото [mm]
1   AP1T MF	990	317	295	400	166
2   AP1T/2 MF	990	317	295	800	166
3   AP2T MF	990	612	590	400	166
4   AP2T/2 MF	990	612	590	800	166
5   AP3T MF	990	912	890	400	166
6   AP3T/2 MF	990	912	890	800	166
7   AP4T MF	990	1212	1190	400	166
8   AP4T/2 MF	990	1212	1190	800	166
9   AP5T MF	990	1472	1450	400	166
10   AP5T/2 MF	990	1472	1450	800	166
11   AP6T MF	990	1797	1775	400	166
12   AP6T/2 MF	990	1797	1775	800	166



## AGRAR

EN

- ▮ Made of strong material PE.
- ▮ Trough and metal elements made of stainless steel (AISI 430).
- ▮ Precise and durable feed flow adjustment.

BG

- ▮ Направени от здрав материал PE.
- ▮ Корито и метални детайли от нерждаема стомана (AISI 430).
- ▮ Прецизен и издръжлив регулиращ механизъм на притока на фураж.

## AP2T AGRAR



Following options available / Предлагани модели

	A	B	C	D	kg/l	Брой животни	Тегло на животите/kg
1   AP 1T AGRAR	990	319	400	180	57	8-10	30-125kg
2   AP 1T/2 AGRAR	990	319	800	180	114	16-20	30-125kg
3   AP 2T AGRAR	990	614	400	180	114	16-20	30-125kg
4   AP 2T/2 AGRAR	990	614	800	180	228	32-40	30-125kg
5   AP 3T AGRAR	990	914	400	180	172	24-30	30-125kg
6   AP 3T/2 AGRAR	990	914	800	180	344	48-60	30-125kg
7   AP 4T AGRAR	990	1214	400	180	230	32-40	30-125kg
8   AP 4T/2 AGRAR	990	1214	800	180	460	64-80	30-125kg
9   AP 5T AGRAR	990	1514	400	180	288	40-50	30-125kg
10   AP 5T/2 AGRAR	990	1514	800	180	576	80-100	30-125kg



## SEP

EN

- ▮ Made of strong material PE.
- ▮ Metal elements made of stainless steel (AISI 430).
- ▮ Precise and durable feed flow adjustment.
- ▮ Additional divider in trough, enabling individual access to trough, less stress for animals.

AP4T SEP



BG

- ▮ Направени от здрав материал PE.
- ▮ Метални детайли от неръждаема стомана (AISI 430).
- ▮ Прецизен и издръжлив регулиращ механизъм на притока на фураж.
- ▮ Допълнителен делител в коритото за индивидуален достъп и по-малко стрес.

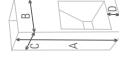

Following options available / Предлагани модели

	A	B	C	D	Kg/l	Брой животни	Тегло на животните/Kg
1   AP 1T SEP	990	319	400	180	57	8-10	30-125kg
2   AP 1T/2 SEP	990	319	800	180	114	16-20	30-125kg
3   AP 2T SEP	990	614	400	180	114	16-20	30-125kg
4   AP 2T/2 SEP	990	614	800	180	228	32-40	30-125kg
5   AP 3T SEP	990	914	400	180	172	24-30	30-125kg
6   AP 3T/2 SEP	990	914	800	180	344	48-60	30-125kg
7   AP 4T SEP	990	1214	400	180	230	32-40	30-125kg
8   AP 4T/2 SEP	990	1214	800	180	460	64-80	30-125kg
9   AP 5T SEP	990	1514	400	180	288	40-50	30-125kg
10   AP 5T/2 SEP	990	1514	800	180	576	80-100	30-125kg





## LUX

EN

- ▮ Made of strong material PE.
- ▮ Trough and metal elements made of stainless steel (AISI 430).
- ▮ Precise and durable stainless steel feed flow adjustment.
- ▮ Stainless steel inside bolt.
- ▮ Reinforced front wall.
- ▮ Longer durability.

AP3T/2 LUX

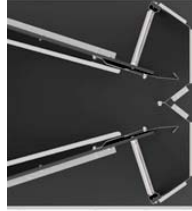

BG

- ▮ Произведени от здрав материал PE.
- ▮ Корито и метални детайли от неръждаема стомана (AISI 430).
- ▮ Прецизен и издръжлив регулиращ механизъм на притока на фураж.
- ▮ Неръждаем вътрешен болт.
- ▮ Усилена предна стена.
- ▮ Удължен експлоатационен живот.

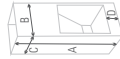

## Following options available / Предлагани модели

	A	B	C	D	Kg/l	Брой животни	Тегло на животинте/kg
1   AP 1T LUX	990	319	400	180	57	8-10	30-125kg
2   AP 1T/2 LUX	990	319	800	180	114	16-20	30-125kg
3   AP 2T LUX	990	614	400	180	114	16-20	30-125kg
4   AP 2T/2 LUX	990	614	800	180	228	32-40	30-125kg
5   AP 3T LUX	990	914	400	180	172	24-30	30-125kg
6   AP 3T/2 LUX	990	914	800	180	344	48-60	30-125kg
7   AP 4T LUX	990	1214	400	180	230	32-40	30-125kg
8   AP 4T/2 LUX	990	1214	800	180	460	64-80	30-125kg
9   AP 5T LUX	990	1514	400	180	288	40-50	30-125kg
10   AP 5T/2 LUX	990	1514	800	180	576	80-100	30-125kg



## WITH DRINKER

EN

- ▮ Made of strong material PE.
- ▮ Trough and drinkers made of stainless steel (AISI 304).
- ▮ Other metal elements made of stainless steel (AISI 430).
- ▮ Precise and durable feed flow adjustment.
- ▮ With integrated drinking bowl separated from feeding area, fitted with stainless steel drinking nipple.

AP2 + TT



## С ПОИЛКА(И)

BG

- ▮ Произведени от здрав материал PE.
- ▮ Корито и поилки от неръждаема стомана (AISI 304).
- ▮ Други метални детайли от неръждаема стомана (AISI 430)
- ▮ Прецизен и издръжлив регулатор на притока на фураж.
- ▮ С поилка(и) тип корито (с нипел) обособена(и) от хранителното корито.

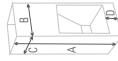

Following options available / Предлагани модели

	A	B	C	D	Kg/	Брой животни	Тегло на животите/Kg
1   AP 1+TT	990	514	400	170	87	8-10	30-125kg
2   AP 1+TT/2	990	514	800	170	174	16-20	30-125kg
3   AP 2+TT	990	814	400	170	144	16-20	30-125kg
4   AP 2+TT/2	990	814	800	170	288	32-40	30-125kg
5   AP 2+2T	990	1004	400	170	174	16-20	30-125kg
6   AP 2+2T/2	990	1004	800	170	348	32-40	30-125kg
7   AP 3+2T	990	1304	400	170	231	24-30	30-125kg
8   AP 3+2T/2	990	1304	800	170	462	48-60	30-125kg

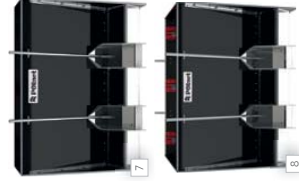

## INOX

EN

- ▮ Made entirely of stainless steel AISI 430 (AISI 304 on request).
- ▮ Precise and durable feed flow adjustment.
- ▮ Foot plate enabling anchoring to floor.
- ▮ Trough edge with additional metal bar preventing feed waste.

AP3T INOX



## НЕРЪЖДАЕМИ

BG

- ▮ Произведени изцяло от неръждаема стомана (AISI 430), (AISI 304 при запитване).
- ▮ Прецизен и издръжлив регулиращ механизъм на притока на фураж.
- ▮ Ъглови плочки за фиксиране към пода.
- ▮ Специален профил на кергитото предотвратяващ пилеене на фураж.

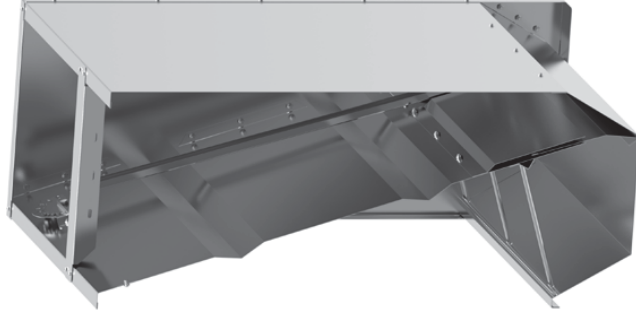

## Following options available / Предлагани модели

	A	B	C	D	Kg/l	Брой животни	Тегло на животни/т/кг
1   AP 1T INOX	1000	297	402	165	60	8-10	30-125kg
2   AP 1T/2 INOX	1000	297	800	165	120	16-20	30-125kg
3   AP 2T INOX	1000	592	402	165	120	16-20	30-125kg
4   AP 2T/2 INOX	1000	592	800	165	240	32-40	30-125kg
5   AP 3T INOX	1000	892	402	165	180	24-30	30-125kg
6   AP 3T/2 INOX	1000	892	800	165	360	48-60	30-125kg
7   AP 4T INOX	1000	1192	402	165	241	32-40	30-125kg
8   AP 4T/2 INOX	1000	1192	800	165	482	64-80	30-125kg
9   AP 5T INOX	1000	1492	402	165	302	40-50	30-125kg
10   AP 5T/2 INOX	1000	1492	800	165	604	80-100	30-125kg





## SF

## EN

- ▮ Made of stainless steel (AISI 304).
- ▮ Welded strong construction.
- ▮ Feeding shelf enabling access to dry feed.
- ▮ Stainless steel nipples under the shelf – slop feed in the trough.
- ▮ Mean to finish design in one feeder – special removable inserts lowering the feeding shelf for small animals.
- ▮ Only double sided option.
- ▮ Precise and durable feed flow adjustment.
- ▮ Trough edge preventing feed waste.
- ▮ Vertical dividers between feeding places, less stress for animals.

## BG

- ▮ Изработени от неръждаема стомана (AISI 304).
- ▮ Здрава заварена конструкция.
- ▮ Корито за хранене, позволяващо достъп до сух фураж.
- ▮ Нипели от неръждаема стомана под коритото – за осъществяване на течно хранене.
- ▮ Дизайн на хранилката (специални подвижни вложки) позволяващ
- ▮ полагането и през целия период - от отбиване до усояване.
- ▮ Прецизен и издръжлив регулиращ механизъм на прилока на фураж.
- ▮ Ръбът на коритото предотвратява разпилването на фураж.
- ▮ Вертикални разделители между местата за хранене, по-малко стрес за животните.

## AP6T/2 SF

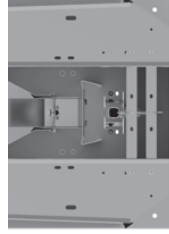

## Following options available / Предлагани модели

	A	B	C	D	Капацитет/kg
1   AP2T/2 SF	782	728	545	117	85
2   AP3T/2 SF	782	1186	545	117	140
3   AP4T/2 SF	782	1490	545	117	175
4   AP5T/2 SF	782	1795	545	117	210
5   AP6T/2 SF	782	2153	545	117	250



## PR INOX

EN

- Special vertical separator between feeding places ensuring individual access to feed and less stress for animals.
- Made of stainless steel AISI 430 (AISI 304 on request).
- Precise feed flow regulation.
- Lower trough edge enables to feed animals from 15kg up to 120kg.

FR

- Spécialien vertical séparateur entre les mangeoires assurant l'accès individuel à la nourriture et moins de stress pour les animaux.
- Réalisé en acier inoxydable AISI 430 (AISI 304 sur demande).
- Régulation précise du débit de nourriture.
- Bord inférieur de la mangeoire permet de nourrir les animaux de 15 à 120 kg.

AP4T/2 PR INOX

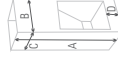
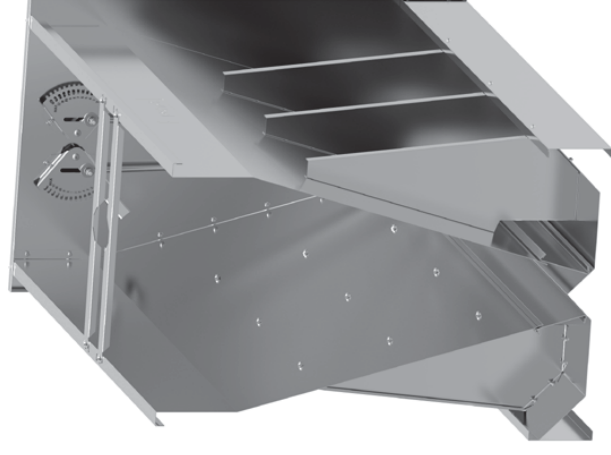

## Following options available / Предлагани модели

	A	B	C	D	Kg/l	Брой животни	Тегло на животинте/kg
1   AP 1T PR INOX	920	342	312	133	49	8-10	15-120kg
2   AP 1T/2 PR INOX	920	342	620	133	98	16-20	15-120kg
3   AP 2T PR INOX	920	682	312	133	98	16-20	15-120kg
4   AP 2T/2 PR INOX	920	682	620	133	196	32-40	15-120kg
5   AP 3T PR INOX	920	1022	312	133	147	24-30	15-120kg
6   AP 3T/2 PR INOX	920	1022	620	133	294	48-60	15-120kg
7   AP 4T PR INOX	920	1362	312	133	196	32-40	15-120kg
8   AP 4T/2 PR INOX	920	1362	620	133	390	64-80	15-120kg
9   AP 5T PR INOX	920	1702	312	133	244	40-50	15-120kg
10   AP 5T/2 PR INOX	920	1702	620	133	488	80-100	15-120kg



## APM

EN

- Box slop feeder for dry feed with simultaneous water supply.
- Drinking nipple in each feeding place.
- Vertical separator of feeding places ensuring individual access to trough for all animals.
- Made of strong material PE.
- Metal elements made of stainless steel.

BG

- Хранилка тип БОКС за сух фураж с поилка тип нипел за мокро хранене.
- Поилка тип нипел във всяко хранително място.
- Вертикален прегради на местата за хранене, за индивидуален достъп до коритото за всяко животно.
- Изработен от здрав материал PE.
- Метални елементи от неръждаема стомана.

## АРМИТ



## Following options available / Предлагани модели

	A	B	C	D	Kg/l	Брой животни	Тегло на животните/Kg
1   АРМИТ	990	349	366	115	66	10	30-125kg
2   АРМ 1Т/2	990	349	732	115	132	20	30-125kg
3   АРМ 2Т	990	646	366	115	134	20	30-125kg
4   АРМ 2Т/2	990	646	732	115	268	40	30-125kg
5   АРМ 3Т	990	1023	366	115	202	30	30-125kg
6   АРМ 3Т/2	990	1023	732	115	404	60	30-125kg
7   АРМ 4Т	990	1360	366	115	270	40	30-125kg
8   АРМ 4Т/2	990	1360	732	115	540	80	30-125kg





## FOR SOWS / ЗА СВИНЕ

EN

Feeders for sows, for dry feed, pellet or meal. Aimed for sows in groups or in farrowing pens. Assure easy, quick and efficient access to feed. Animal friendly form, no sharp edges, less stress for animals and assured good body condition of all sows. Made of strong materials, reliable regulation knob.

BG

Хранилки за свине майки, за сух фураж: гранулиран или брашноест. Предназначени за бременни и кърмещи свине майки. Осигуряват лесен и бърз достъп до фуража. Подходящ за животните дизайн, без остри ръбове. Изработени от здрави материали, с надежден механизъм за регулиране.



## APM-L

EN

- | Ad libitum feeder for pregnant sows.
- | Drinking nipple.
- | Ensures easy access to feed for all sows in small or large groups.
- | Made of strong material PE.
- | Metal elements made of stainless steel.
- | Special "v" cuttings on side walls for better sows head access.

APM-L

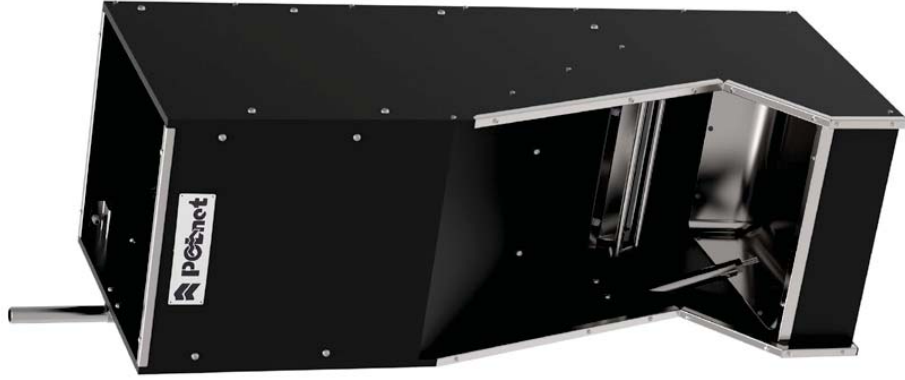

BG

- | Хранилка за хранене на воля на бременни свине.
- | Нипелна поилка.
- | Осигуряват лесен достъп до храна за всички свине майки в малки и големи групи.
- | Изработени от здрав материал PE.
- | Метални елементи от неръждаема стомана.
- | Специални V - образни изрези на страничните стени за по-добър достъп на свинете.



Following options available / Предлагани модели

	A	B	C	D	Kg/l	Бр.	Тегло на животните/Kg
1   APM-L	950	349	366	115	66	15	30-125kg

## AP-L

EN

- | Feeder for sows to be hung on a wall in a farrowing pen, above a trough, easy to install.
- | Ad libitum feeder for nursing sows.
- | Dispenser ensures fresh feed in a trough.
- | Made of strong material PE, metal elements made of stainless steel.
- | Animal friendly form, no sharp edges, minimum feed waste, easy to clean.
- | 2 versions : made entirely of stainless steel, made of PE plate with stainless steel front plate.

## AP-L STANDARD

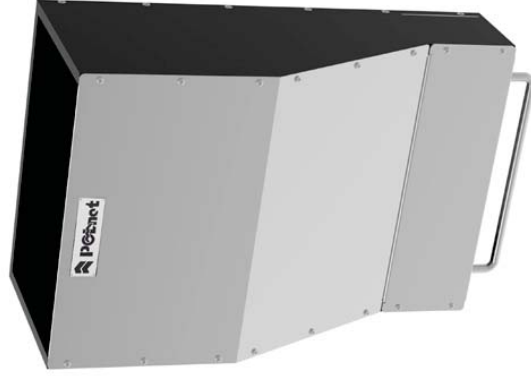
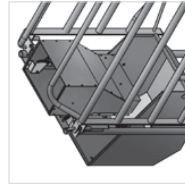
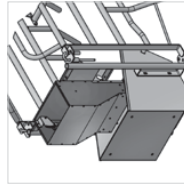
2 INSTALLATION  
POSSIBILITIES:2 ВЪЗМОЖНОСТИ  
ЗА ИНСТАЛИРАНЕ:

Following options available / Предлагани модели

	A	B	C	Kg/l	pc/br
AP-L Standard	500	320	200	19	1

BG

- | Дозатор за кърмещи свине за монтаж (окачване) над коритото.
- | За хранене на кърмещи свине, на воля.
- | Осигурява приток от фураж в корито, на малки порции (без разпльиване).
- | Изработен от здрав материал PE, с метални елементи от неръждаема стомана.
- | Подходящ за животните дизайн, без остри ръбове, лесен за почистване.
- | 2 версии: изработен изцяло от неръждаема стомана, или с корпус от PE и с предна плоскост от неръждаема стомана.

## AP-L INOX

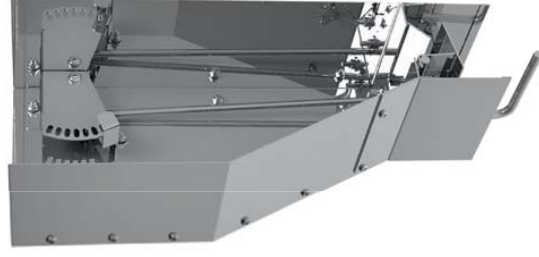

Following options available / Предлагани модели

	A	B	C	Kg/l	pc/br
AP-L INOX	500	320	200	19	1



## SM AD LIBITUM SOW FEEDER MADE OF STAINLESS STEEL

EN

- Full feed intake, feed available for sows 24/7.
- For sows to be hung on a wall in a farrowing and gestation units, above a trough, easy to install.
- Ad libitum feeder for nursing sows.
- Sow eats **when** and **how much** shePwants.
- Dispenser ensures fresh feed inPaPtrough.
- Easy reactive trigger.
- Made of stainless steel.
- Animal friendly form, no sharp edges.
- Minimum feed waste.
- Easy and solid construction, easy to clean.

- AD LIBITUM
- REDUCED FEED WASTE
- INCREASED SOW INTAKE
- STRESS – FREE BREADING

## ХРАНИЛКИ ОТ НЕРЪЖДАЕМА СТОМА- НА ЗА ХРАНЕНЕ НА СВИНЕ НА ВОЛЯ

BG

- Неограничена консумация на храна, наличен фураж за свинете майки 24/7.
- Дозатори за бременни и кърмещи свине, които се монтират над коритото.
- Свинята яде, **когато** и **колко**то иска.
- Дозаторът осигурява фуража в коритото на малки порции.
- Ефективен дозиращ механизъм.
- Изработен от неръждаема стомана.
- Удобен за животните дизайн, без остри ръбове.
- Минимални загуби на фураж.
- Лесно и бързо монтиране, лесно почистване.

- ХРАНЕНЕ НА ВОЛЯ
- НАМАЛЕНО РАЗТИЛЯВАНЕ НА ФУРАЖ
- ПОВИШЕНА КОНСУМАЦИЯ НА ФУРАЖ
- ОТПЛЕЖДАНЕ БЕЗ СТРЕС

### ADJUSTABLE LEVEL

- Precise regulation.
- Precise amount of feed released with each trigger movement.
- Adapted to individual sow behavior.
- РЕГУЛАТОР НА НИВОТО
- Прецизна регулация.
- Точно количество освободен фураж при всяко движение на спусъка.
- Адаптиран към индивидуалното поведение на свинете.



### EASY REACTIVE TRIGGER

- The trigger moves in EVERY direction( not only side to side or front/back) resulting in instinctual feed release.
- ЛЕСНО ЗАДЕЙСТВАНЕ НА СПУСЪКА
- Спусъкът се движи във ВСИЧКИ посоки (не само настрани или напред/назад).



- Задействането му води до автоматично освобождаване на фураж.



### EASY INSTALLATION

- Multiple mounting spots allow easy installation to existing crates.
- ЛЕСЕН МОНТАЖ
- Многото възможности за монтаж позволяват лесно инсталиране към съществуващите фиксатори.

### MAINTENANCE

- Water proof, no need for removal while cleaning.
- 100% stainless steel.
- Long durability.
- ПОДДРЪЖКА
- Водоустойчив, не се налага демонтаж за почистване.
- 100% неръждаема стомана.
- Дълъг експлоатационен живот.

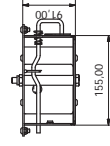
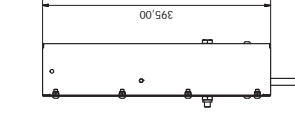
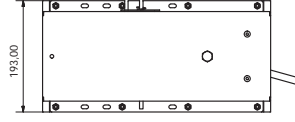
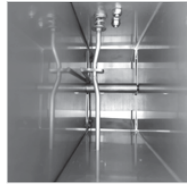

## OPTIONALLY WITH AN EXTENSION ОПЦИОНАЛНО С НАДСТРОЙКА



## SWING AD LIBITUM SOW FEEDER

- EN** | For sows in farrowing and gestation units. | Ad libitum feeding.
- | Sow eats **when** and **how much** she wants. | Feed available for 24/7.
- | Reduced feed waste.
- | Small portions of fresh feed.
- | Easy reactive trigger.
- | Adapted to different types of feed.
- | Easy and solid construction.

- AD LIBITUM**
- REDUCED FEED WASTE**
- INCREASED SOW INTAKE**
- STRESS – FREE BREADING**



**OPTIONS**  
SWING FEEDER WITH WINDOW

## ХРАНЕНЕ НА СВИНЕТЕ НА ВОЛЯ

**BG**

- | За бременни и кърмещи свине.
- | Хранене на воля.
- | Свинята яде **когато** и **колко** иска.
- | Храната е на разположение 24/7.
- | Фуражът се дозира на малки порции.
- | Намалено разпиляване на фураж.
- | Ефективен дозирач механизъм.
- | Подходящ за всички видове фуражи.
- | Здрава конструкция.

- ХРАНЕНЕ НА ВОЛЯ**
- НАМАЛЕНО РАЗПИЛЯВАНЕ НА ФУРАЖ**
- ПОВИШЕНА КОНСУМАЦИЯ НА ФУРАЖ**
- ОТПГЛЕЖДАНЕ БЕЗ СТРЕС**



**ОПЦИИ**  
ДОЗАТОР ЛЮЛКА С ПРОЗОРЕЦ

## ADJUSTABLE LEVEL

- | Precise amount of feed released with each trigger movement
- | Adapted to individual sow behavior.
- РЕГУЛИРУЕМО НИВО**
- | Точно количество фураж се освобождава с всяко докосване на спусъка.
- | Адаптиран към индивидуалното поведение на свинете.



## INTERNAL FUNNEL

- | Better feed flow regardless feed type (pellet or meal).
- | Eliminates edge bridging
- ВЪТРЕШНОСТ НА ДОЗАТОРА**
- | По-добър приток на фураж, независимо от типа му (пелети или брашно).
- | Елиминира засядаването на фуража



## EASY REACTIVE TRIGGER

- | The trigger moves in EVERY direction. (Not only side to side or front/back resulting in instinctual feed release.
- ЛЕСНО ДОЗИРАНЕ НА ФУРАЖА**
- | Спусъкът се движи във ВСЯКА посока (не само настрани или напред/назад), което води до лесно освобождаване на храната.

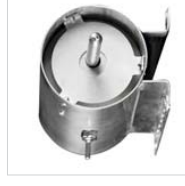

## MOUNTING METHODS

### НА ЧИНИ НА МОНТИРАНЕ



**AD LIBITUM**  
hand feed

**НА ВОЛЯ**  
ръчно зареждане

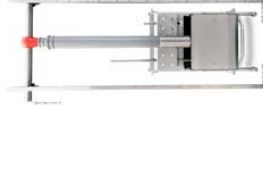

**AD LIBITUM**  
feed line with buffer

**НА ВОЛЯ**  
автоматично зареждане

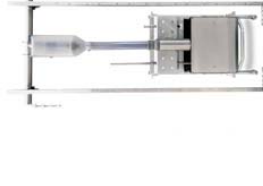

**RESTRICTED**  
feed line with dispenser

**ПОСРЕДСТВО**  
автоматично с дозатор

## EASY AND SOLID CONSTRUCTION

- | Round shape, no corners.
- | Simple form, minimum joints.
- | Animal friendly form.
- | Firm construction.



## ОПРОСТЕНА И ЗДРАВА КОНСТРУКЦИЯ

- | Кръгла форма, без ъгли.
- | Опростен дизайн, с минимум връзки.
- | Форма благоприятна за животните.
- | Стабилна конструкция.

## EASY INSTALLATION

- | Multiple mounting spots allow easy installation to existing crates.
- | Many bean holes assure solid and fixed mounting.

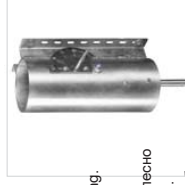

## ЛЕСЕН МОНТАЖ

- | Много възможности за монтаж позволяват лесно инсталиране към съществуващите фиксатори.
- | Многобройните болтови връзки осигуряват стабилен монтаж.

## MAINTENANCE

- | Water proof, no need for removal while cleaning.
- | 100% stainless steel.
- | Long durability.



## ПОДДРЪЖКА

- | Водостойчив, не се налага демонтаж за почистване.
- | 100% неръждаема стомана.
- | Дълъг експлоатационен живот.



## AGRI

EN

- Stainless steel feeder for sows in a farrowing pen.
- Approx. 10kg feed storage hopper.
- Feeding shelf.
- Special shape preventing feed loss.
- Animal friendly design, no sharp edges.

BG

- Хранилка от неръждаема стомана за кърмещи свине.
- Прибл. 10 kg бункер за съхранение на фураж.
- Корито за хранене.
- Специална форма, предотвратяваща пилеенето на фураж.
- Подходящ за животните дизайн, без остри ръбове.

AGRI

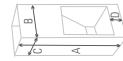

Following options available / Предлагани модели

	A	B	C	D	Kg/l	pc/br
1   AGRI	595	305	390	115	11,5	1

## BIG AGRI

EN

- Stainless steel feeder for sows in a farrowing pen.
- Approx. 10kg feed storage hopper.
- Feeding shelf.
- Special shape preventing feed loss.
- Animal friendly design, no sharp edges.

BG

- Хранилка от неръждаема стомана за кърмещи свине.
- Прибл. 10 kg бункер за съхранение на фураж.
- Корито за хранене.
- Специална форма, предотвратяваща пилеенето на фураж.
- Подходящ за животните дизайн, без остри ръбове.

BIG AGRI

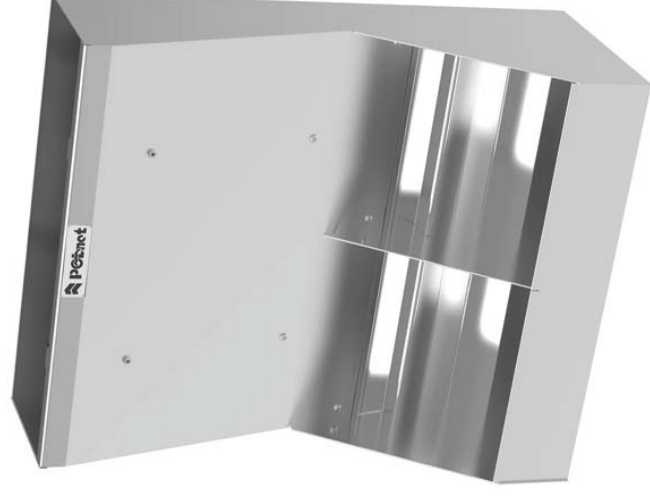

Following options available / Предлагани модели

	A	B	C	D	Kg/l	pc/br
1   BIG AGRI	990	801	390	150	101	2



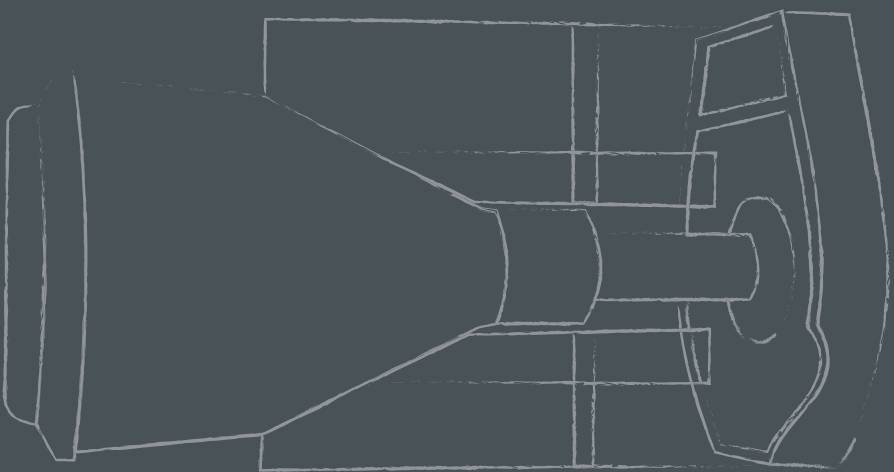

T

U

B

O

EN

Feeders for dry feed; pellet of meal with simultaneous access to water. Aimed for weaners or fatteners - depending on trough size. Feeders are suitable to stand alone in a pen or to be integrated into partition wall. Variable shape of water pipes with nipples above a trough. Reliable feed flow regulation hand. Animal friendly form.

BG

Хранилки за сух фураж, пелетиран или брашнест, с едновременно достъп до вода. Предназначени за отбити или уговявани прасета - в зависимост от размера на коритото. Хранилките могат да стоят самостоятелно в бокса или да се интегрират в преградната стена. Променилива форма на водопроводни тръби с нипели над коритото. Надеждно ръчно регулиране на притока на фураж. Подходящ за животните дизайн.



WSKK NSN25

FOR WEANERS | ЗА ОТБИТИ ПРАСЕТА

EN

- Stainless steel mould trough, straight shape.
- 2-sided water bowls.
- L-shaped profiles as standard.

BG

- Неръждаемо корито със заоблена форма.
- 2-странични купи за вода.
- L-образни профили като стандарт.

WSKK NSN25

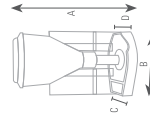

Following options available / Предлагани модели

	A	B	C	D	Kg/l	pc/bp
1   WSKK NSN25	1250	62,5	410	90	120	50

W-TSKK NWF24  
TSKK NSF27

FOR FATTENERS / ЗА УГОЯВАНИ ПРАСЕТА

EN

- Stainless steel mould trough, straight shape.
- 4-sided water bowl.
- L-shaped profiles as standard.

BG

- Неръждаемо корито със заоблена форма.
- 4-странична купа за вода.
- L-образни профили като стандарт.

W-TSKK NWF24

TSKK NSF27

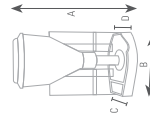
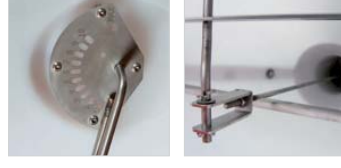

Following options available / Предлагани модели

	A	B	C	D	Kg/l	pc/bp
1   W-TSKK NWF24	1250	62,0	480	110	120	50
2   TSKK NSF27	1250	69,0	535	115	120	50



## TSKK NDWF50

EN

- | Wren to finish type.
- | Stainless steel mould trough.
- | Two separate storage tubes.

BG

- | За отбити и уговявани прасета.
- | Неръждаемо корито със заоблена форма.
- | Два отделни контейнера за фураж.

EN

- | Wren to finish type.
- | Stainless steel trough.
- | Enlarged hopper capacity.
- | Swing outlet system – precise and easy in use for animals.

FR

- | За отбити и уговявани прасета.
- | Корито от неръждаема стомана.
- | Увеличен капацитет на контейнера.
- | Полюеще се изпускателна система – прецизна и лесна за използване от животните.

TSKK NDWF50

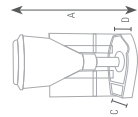

Following options available / Предлагани модели

	A	B	C	D	Kg/l	pc/br
1   TSKK NDWF50	1250	1325	480	125	240	100

TSKK SWING

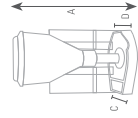

Following options available / Предлагани модели

	A	B	C	D	Kg/l	pc/br
1   TSKK SWING	1230	1145	395	95	200	100

**PSKK**

FOR PIGLETS | ЗА БОЗАЕЩИ ПРАСЕТА

EN

- Stainless steel mould trough, round shape, Ø50cm.
- Round water line with 6 nipples.
- Separator of feeding places, less stress for animals.

FR

- Неръждаемо корито със заоблена форма, Ø50 см.
- Кръгъл водопровод с 6 нипела.
- Разделител на местата за хранене, по-малко стрес за животните.

PSKK

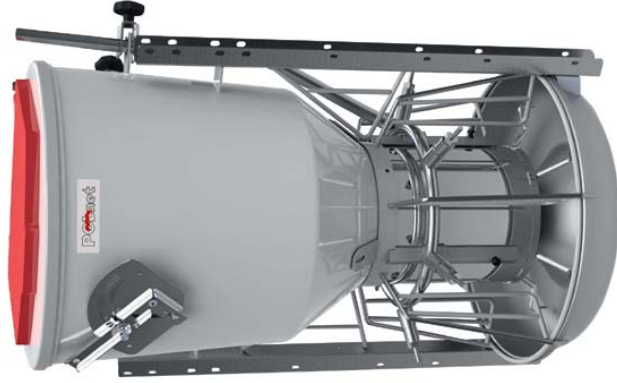

OPTIONAL  
ОПЦИЯ

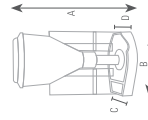

Following options available / Предлагани модели

	A	B	C	D	E	Kg/l	pc/bp
1   PSKK	875	500	500	100		70	50

**WSKK SNR**

FOR WEANERS | ЗА ОТБИТИ ПРАСЕТА

EN

- Stainless steel mould trough, round shape, Ø60cm.
- Round water line, available with height regulation, 6 nipples.
- Separated feeding places, less stress for animals.
- Available with side profiles to partition wall.

BG

- Неръждаемо корито със заоблена форма Ø60см.
- Кръгъл водопровод, 6 нипела, предпаз се с регулиране на височината.
- Отделни места за хранене, по-малко стрес за животните.
- Предпаз се със странични профили към преградна стена.

WSKK SNR

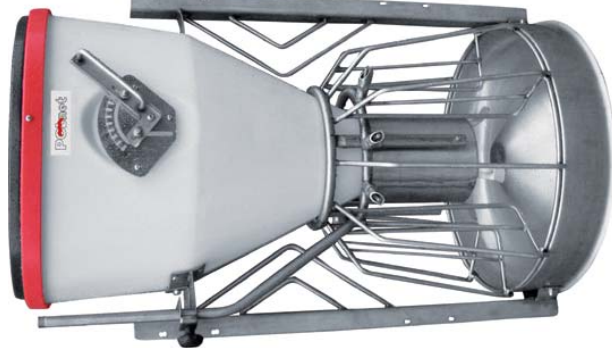

OPTIONAL  
ОПЦИЯ

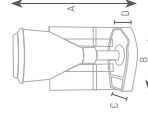

Following options available / Предлагани модели

	A	B	C	D	E	Kg/l	pc/bp
1   WSKK SNR	1250	640	610	105		120	50

TSKK SFR

FOR FATTENERS | ЗА УГОЯВАНИ ПРАСЕТА

EN

- Stainless steel mould trough, round shape Ø76cm.
- Round water line with 4 nipples, available with height regulation.
- Separator of feeding places, less stress for animals during eating.
- Available with side profiles to partition wall.

BG

- Неръждаемо корито със заоблена форма Ø76см.
- Кръгъл водопровод с 4 нипела, предлагат се с регулиране на височината.
- Разделител на местата за хранене, по-малко стрес за животните по време на хранене.
- Предлагат се със странични профили към преградна стена.

TSKK SFR

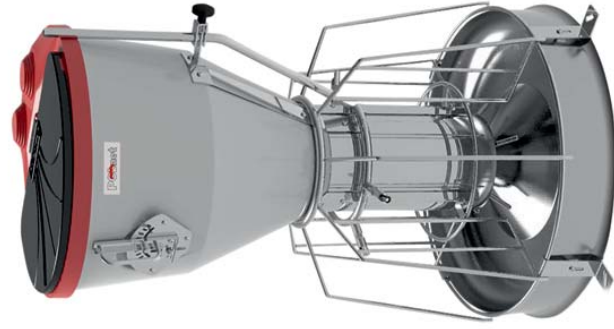

OPTIONAL

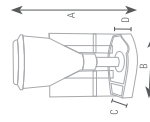

Following options available / Предлагани модели

	A	B	C	D	Kg/l	pc/bp
1   TSKK SFR	1250	770	745	155	120	100

MB

АВТОМАТИЧНА ХРАНИЛКА MB

EN

- Dosator for: CCM or pellets/meals.
- Trough, regulation and all finishing made of high-quality stainless steel.
- Movable plastic tube (optional).
- Easy for cleaning.
- Tube capacity = 100kg.
- Different colours of plastic tube available on request.
- Available: 1 water line with 4 nipples or 2 water lines with 2 nipples each.
- Precise feed flow regulation.

BG

- Дозатор за: ССМ, пелетирана или брашнаеста смеска.
- Корито, регулиращ механизъм и всички други метални детайли от висококачествена неръждаема стомана.
- Подвижен пластмасов контейнер (опция).
- Лесно почистване.
- Капацитет на контейнера = 100 Кг.
- Предлагат се с различни цветове на контейнера при поискване.
- Налични: 1 водопровод с 4 нипела или 2 водопровода с по 2 нипела.
- Прецизно регулиране на храняващия поток.



MB

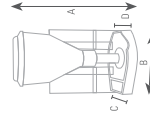

Following options available / Предлагани модели

	A	B	C	D	Kg/l	pc/bp
1   MB	1430	595	560	135	140	50



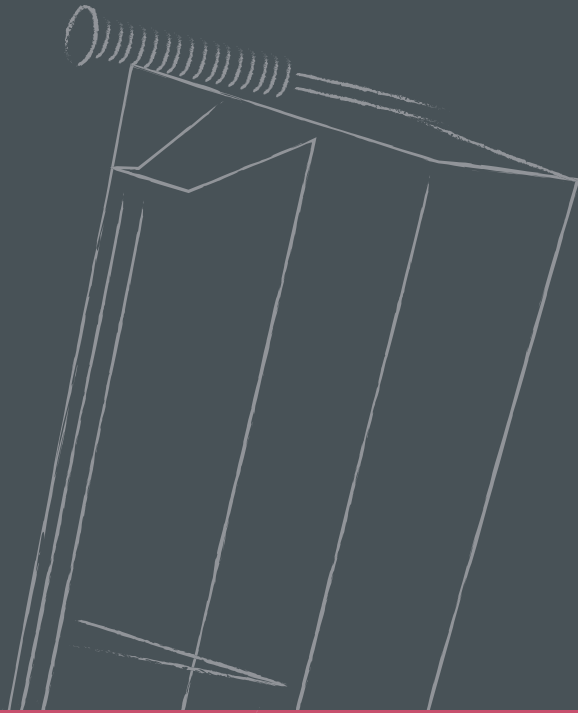

TK  
TRO  
PUN  
T  
A  
TR  
O  
UN  
G  
HA



EN

Trough for dry feed, slop feed or also water. Easy fastening to slatted floor with spring hooks. Separators of feeding places ensure easy access to the trough for all animals in a group and prevent animals from entering the trough. Animal friendly form, no sharp edges, minimum feed waste, easy to clean.

BG

Корито за сух фураж, течно хранене или поене. Лесно закрепване към скеровия под с пружинни куки. Разделителите на местата за хранене осигуряват лесен достъп до коритото за всички прасета в групата и предотвратяват влизането на животните в коритото. Подходяща за животните форма, без остри ръбове, минимално пилеене на фураж, лесно почистване.

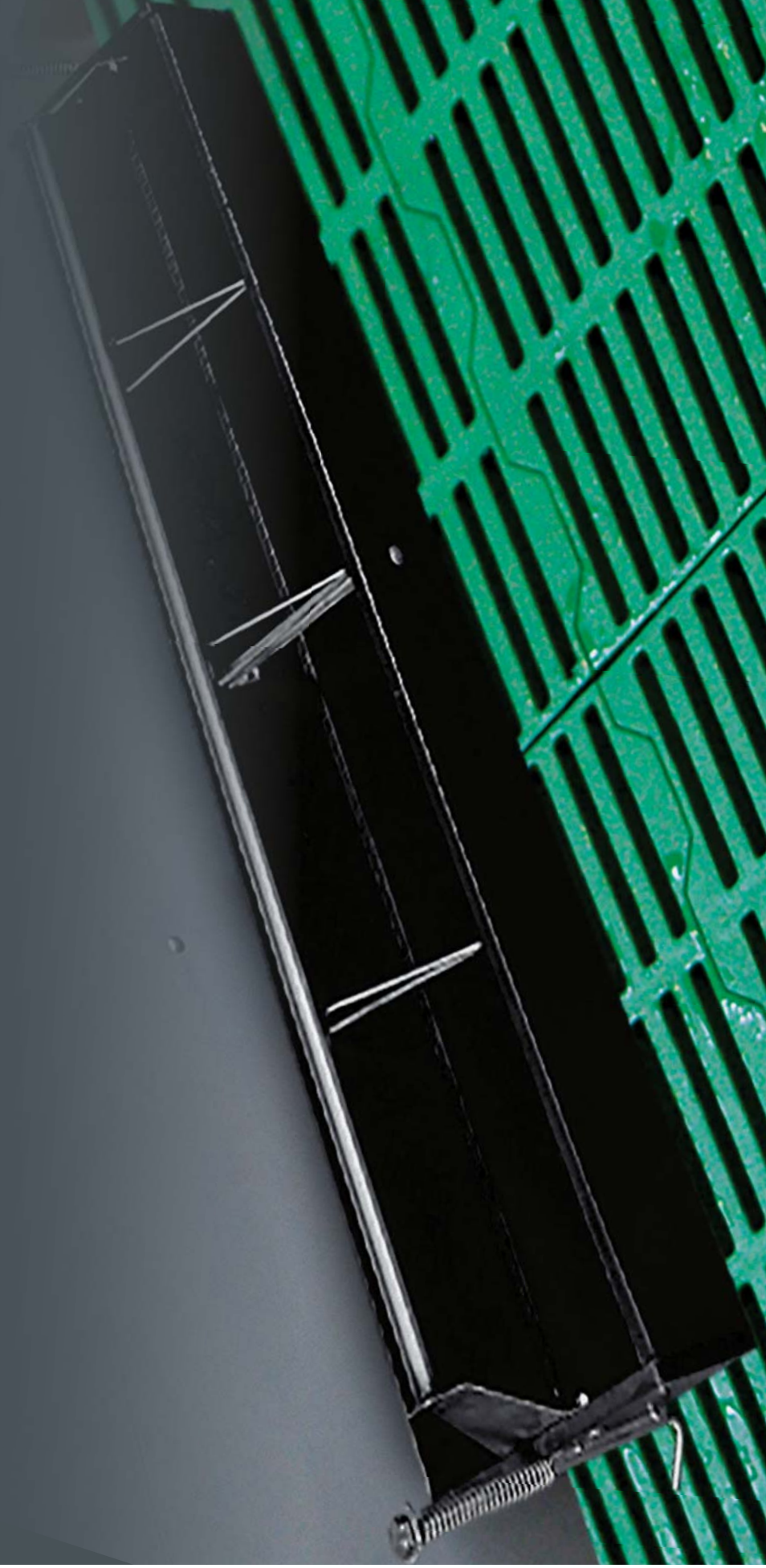

PE

EN

- Made of strong material PE.
- Available length: 1m; 1.5m; 2m.

BG

- Изработени от здрав материал PE.
- Предлагани дължини: 1м; 1,5м; 2м.



Dimensions / Размери

	A	B	C
PE корито 1 m	110	1000	290
PE корито 1,5 m	110	1500	290
PE корито 2 m	110	2000	290

STAINLESS STEEL

EN

- Made entirely of stainless steel (AISI 304).
- Available length: 1m; 1.5m; 2m.

BG

- Изработени изцяло от неръждаема стомана (AISI 304).
- Предлагани дължини: 1м; 1,5м; 2м.



Dimensions / Размери

	A	B	C
Неръждаемо корито 1 m	110	1000	290
Неръждаемо корито 1,5 m	110	1500	290
Неръждаемо корито 2 m	110	2000	290





POLNET Sp. z o.o.  
i Wspólnicy  
Spółka Komandytowa

ul. Sowia 13 B  
62-080 Tarnowo Podgórne, Polska  
tel.: + 48 61 657 67 00, fax: + 48 61 657 67 67  
office@polnet.pl

| **Export Head Office:**  
+ 48 600 461 134  
+ 48 662 027 069

| **Belgium Departament:**  
+ 32 485 51 84 97

| **Austrian Departament:**  
+ 43 676 56 11 288

Дилър за България

Агротех Консулт ЕООД,  
ул. Хр . Смирненски No 97  
6000 Стара Загора, България  
тел./факс: 042 637899,  
моб.: 0897 284 517, 0898 962 171

[www.agrotech-consult.com](http://www.agrotech-consult.com)  
[l.stefanov@agrotech-consult.com](mailto:l.stefanov@agrotech-consult.com)  
[v.doichev@agrotech-consult.com](mailto:v.doichev@agrotech-consult.com)

[www.polnet.pl](http://www.polnet.pl)

